

Stereotypes

UseCase	
Tagged Value Definitions	Level
	Author admin
	Create Date Time Feb 25, 2010 11:45:00 AM
	Last Modified Mar 22, 2010 2:32:17 PM
	Type Enumeration
	Complexity
	Author admin
	Create Date Time Feb 25, 2010 11:45:00 AM
	Last Modified Mar 22, 2010 2:32:17 PM
	Type Enumeration
	Use Case Status
	Author admin
	Create Date Time Feb 25, 2010 11:45:00 AM
	Last Modified Mar 22, 2010 2:32:17 PM
	Type Enumeration
	Implementation Status
	Author admin
	Create Date Time Feb 25, 2010 11:45:00 AM
	Last Modified Mar 22, 2010 2:32:17 PM
	Type Enumeration
	Preconditions
	Author admin
	Create Date Time Feb 25, 2010 11:45:00 AM
	Last Modified Mar 22, 2010 2:32:17 PM
	Type Multi-line Text
	Post-conditions
	Author admin
	Create Date Time Feb 25, 2010 11:45:00 AM
Last Modified Mar 22, 2010 2:32:17 PM	

	Type	Multi-line Text
	Author	
	Author	admin
	Create Date Time	Feb 25, 2010 11:45:00 AM
	Last Modified	Mar 22, 2010 2:32:17 PM
	Type	Text
	Assumptions	
	Author	admin
	Create Date Time	Feb 25, 2010 11:45:00 AM
	Last Modified	Mar 22, 2010 2:32:17 PM
	Type	Multi-line Text



Sequence Diagram

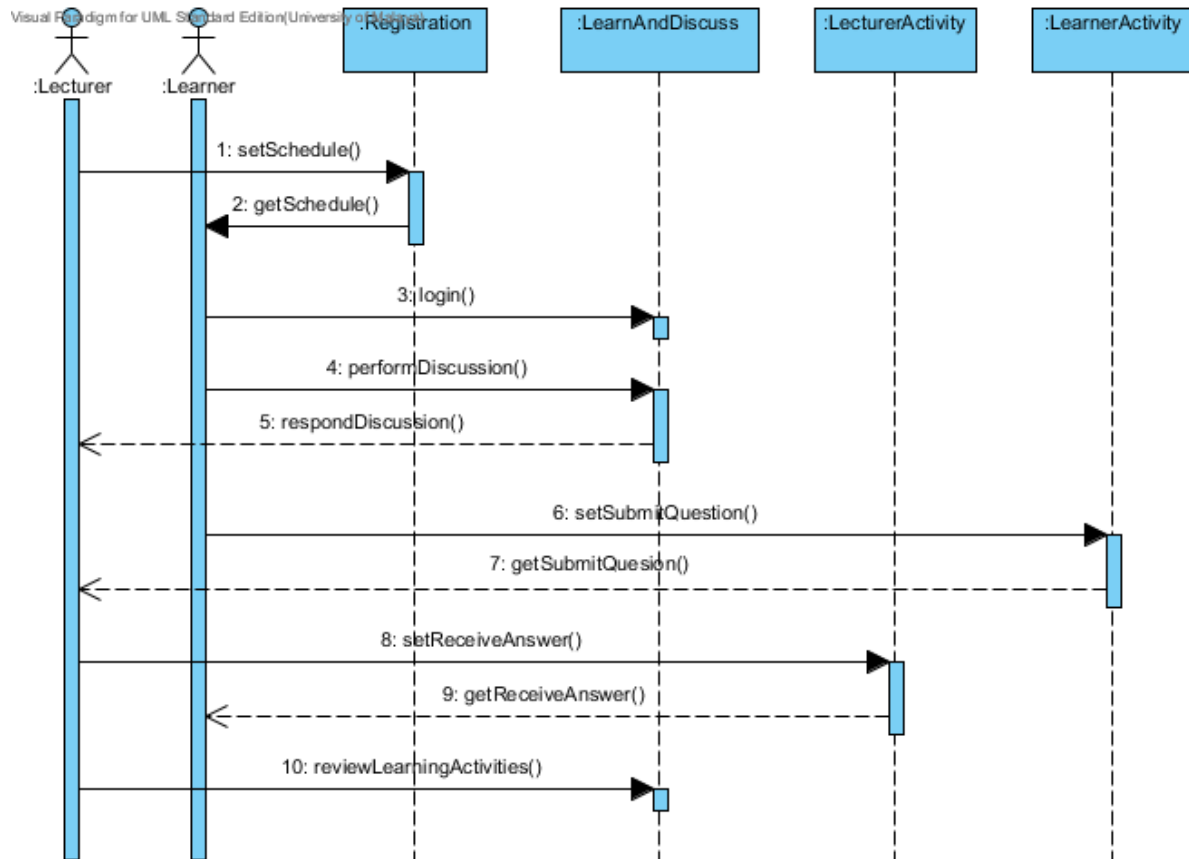

DLS Sequence Diagram



Name	Value
Author	wek080083
Create Date Time	Mar 22, 2010 2:31:36 PM
Last Modified	Mar 22, 2010 2:39:14 PM
Name	DLS Sequence Diagram

Summary

Name	Documentation
 :Lecturer	Setting the schedule of each of the available courses, perform discussion where requested by the learner. During the learning activities, the lecturer will get the question submitted by the learner and set the answer of the question. After all the learning activities had been done, the lecturer will review the learning activities.
 :Registration	Providing the framework to set and get the course schedule onced the registration of the learner.
 :Learner	Get the schedule after registration, perform discussion with the lecturer, if have any question to ask the lecturer will submit question and after the lecturer set the answer, get the received answer

 :LearnAndDiscuss	A framework of the learning activities performed by the user. A place to perform any discussions.
 :LearnerActivity	The subclass of LearnAnd Discuss where the questions of the discussion is set or submitted and get from here.
 :LecturerActivity	Another subclass of LearnAndDiscuss where the answer of the discussion is set and get from here.

Details





:Lecturer

Name	Value
Visibility	public
Abstract	false
Leaf	false
Root	false
Author	wek080083
Create Date Time	Mar 22, 2010 2:31:36 PM
Last Modified	Mar 22, 2010 2:38:19 PM
Active	false
Business Model	false

Relationships

setSchedule() : Message		
To	Name	Value
	End Model Element	 :Registration
	Author	wek080083
	Create Date Time	Mar 22, 2010 2:31:36 PM
	Last Modified	Mar 22, 2010 2:32:17 PM
	Author	wek080083
Create Date Time	Mar 22, 2010 2:31:36 PM	
Last Modified	Mar 22, 2010 2:32:17 PM	
Type	Message	
Sequence Number	1	
Asynchronous	false	

setReceiveAnswer() : Message		
To	Name	Value
	End Model Element	 :LecturerActivity
	Author	wek080083
	Create Date Time	Mar 22, 2010 2:31:36 PM
	Last Modified	Mar 22, 2010 2:38:19 PM
Author	wek080083	
Create Date Time	Mar 22, 2010 2:31:36 PM	
Last Modified	Mar 22, 2010 2:38:19 PM	
Type	Message	
Sequence Number	8	
Asynchronous	false	

reviewLearningActivities() : Message		
To	Name	Value
	End Model Element	 :LearnAndDiscuss
	Author	wek080083
	Create Date Time	Mar 22, 2010 2:31:36 PM
	Last Modified	Mar 22, 2010 2:32:17 PM
Author	wek080083	
Create Date Time	Mar 22, 2010 2:31:36 PM	
Last Modified	Mar 22, 2010 2:32:17 PM	
Type	Message	
Sequence Number	10	
Asynchronous	false	

respondDiscussion() : Message		
From	Name	Value
	End Model Element	 :LearnAndDiscuss
	Author	wek080083
	Create Date Time	Mar 22, 2010 2:31:36 PM
	Last Modified	Mar 22, 2010 2:38:19 PM
Author	wek080083	
Create Date Time	Mar 22, 2010 2:31:36 PM	

Last Modified	Mar 22, 2010 2:38:19 PM	
Type	Message	
Sequence Number	5	
Action Type	Name	Value
	Name	Return
	Iteration	false
	Asynchronous	false
	Author	wek080083
	Create Date Time	Mar 22, 2010 2:31:36 PM
	Last Modified	Mar 22, 2010 2:38:19 PM
Asynchronous	false	

getSubmitQuestion() : Message		
From	Name	Value
	End Model Element	 :LearnerActivity
	Author	wek080083
	Create Date Time	Mar 22, 2010 2:31:36 PM
	Last Modified	Mar 22, 2010 2:38:19 PM
Author	wek080083	
Create Date Time	Mar 22, 2010 2:31:36 PM	
Last Modified	Mar 22, 2010 2:38:19 PM	
Type	Message	
Sequence Number	7	
Action Type	Name	Value
	Name	Return
	Iteration	false
	Asynchronous	false
	Author	wek080083
	Create Date Time	Mar 22, 2010 2:31:36 PM
	Last Modified	Mar 22, 2010 2:38:19 PM
Asynchronous	false	





:Registration

Name	Value
------	-------

Author	wek080083
Create Date Time	Mar 22, 2010 2:31:36 PM
Last Modified	Mar 22, 2010 2:32:17 PM
Multiplicity	Unspecified
Active	false
Stopped	false
Multi Object	false

Relationships

getSchedule() : Message		
To	Name	Value
	End Model Element	 :Learner
	Author	wek080083
	Create Date Time	Mar 22, 2010 2:31:36 PM
	Last Modified	Mar 22, 2010 2:32:17 PM
Author	wek080083	
Create Date Time	Mar 22, 2010 2:31:36 PM	
Last Modified	Mar 22, 2010 2:32:17 PM	
Type	Message	
Sequence Number	2	
Asynchronous	false	

setSchedule() : Message		
From	Name	Value
	End Model Element	 :Lecturer
	Author	wek080083
	Create Date Time	Mar 22, 2010 2:31:36 PM
	Last Modified	Mar 22, 2010 2:32:17 PM
Author	wek080083	
Create Date Time	Mar 22, 2010 2:31:36 PM	
Last Modified	Mar 22, 2010 2:32:17 PM	
Type	Message	
Sequence Number	1	
Asynchronous	false	



:Learner

Name	Value
Visibility	public
Abstract	false
Leaf	false
Root	false
Author	wek080083
Create Date Time	Mar 22, 2010 2:31:36 PM
Last Modified	Mar 22, 2010 2:38:19 PM
Active	false
Business Model	false

Relationships

login() : Message		
To	Name	Value
	End Model Element	:LearnAndDiscuss
	Author	wek080083
	Create Date Time	Mar 22, 2010 2:31:36 PM
	Last Modified	Mar 22, 2010 2:32:17 PM
	Author	wek080083
Create Date Time	Mar 22, 2010 2:31:36 PM	
Last Modified	Mar 22, 2010 2:32:17 PM	
Type	Message	
Sequence Number	3	
Asynchronous	false	

performDiscussion() : Message		
To	Name	Value
	End Model Element	:LearnAndDiscuss
	Author	wek080083
	Create Date Time	Mar 22, 2010 2:31:36 PM
	Last Modified	Mar 22, 2010 2:32:17 PM
	Author	wek080083
Create Date Time	Mar 22, 2010 2:31:36 PM	

Last Modified	Mar 22, 2010 2:32:17 PM
Type	Message
Sequence Number	4
Asynchronous	false

setSubmitQuestion() : Message		
To	Name	Value
	End Model Element	 :LearnerActivity
	Author	wek080083
	Create Date Time	Mar 22, 2010 2:31:36 PM
	Last Modified	Mar 22, 2010 2:38:19 PM
Author	wek080083	
Create Date Time	Mar 22, 2010 2:31:36 PM	
Last Modified	Mar 22, 2010 2:38:19 PM	
Type	Message	
Sequence Number	6	
Asynchronous	false	

getSchedule() : Message		
From	Name	Value
	End Model Element	 :Registration
	Author	wek080083
	Create Date Time	Mar 22, 2010 2:31:36 PM
	Last Modified	Mar 22, 2010 2:32:17 PM
Author	wek080083	
Create Date Time	Mar 22, 2010 2:31:36 PM	
Last Modified	Mar 22, 2010 2:32:17 PM	
Type	Message	
Sequence Number	2	
Asynchronous	false	

getReceiveAnswer() : Message		
From	Name	Value
	End Model Element	 :LecturerActivity
	Author	wek080083

	Create Date Time	Mar 22, 2010 2:31:36 PM
	Last Modified	Mar 22, 2010 2:38:19 PM
Author	wek080083	
Create Date Time	Mar 22, 2010 2:31:36 PM	
Last Modified	Mar 22, 2010 2:38:19 PM	
Type	Message	
Sequence Number	9	
Action Type	Name	Value
	Name	Return
	Iteration	false
	Asynchronous	false
	Author	wek080083
	Create Date Time	Mar 22, 2010 2:31:36 PM
	Last Modified	Mar 22, 2010 2:38:19 PM
Asynchronous	false	



:LearnAndDiscuss

Name	Value
Author	wek080083
Create Date Time	Mar 22, 2010 2:31:36 PM
Last Modified	Mar 22, 2010 2:32:17 PM
Multiplicity	Unspecified
Active	false
Stopped	false
Multi Object	false

Relationships

respondDiscussion() : Message		
To	Name	Value
	End Model Element	 :Lecturer
	Author	wek080083
	Create Date Time	Mar 22, 2010 2:31:36 PM
	Last Modified	Mar 22, 2010 2:38:19 PM

Author	wek080083	
Create Date Time	Mar 22, 2010 2:31:36 PM	
Last Modified	Mar 22, 2010 2:38:19 PM	
Type	Message	
Sequence Number	5	
Action Type	Name	Value
	Name	Return
	Iteration	false
	Asynchronous	false
	Author	wek080083
	Create Date Time	Mar 22, 2010 2:31:36 PM
	Last Modified	Mar 22, 2010 2:38:19 PM
Asynchronous	false	

login() : Message		
From	Name	Value
	End Model Element	 :Learner
	Author	wek080083
	Create Date Time	Mar 22, 2010 2:31:36 PM
	Last Modified	Mar 22, 2010 2:32:17 PM
Author	wek080083	
Create Date Time	Mar 22, 2010 2:31:36 PM	
Last Modified	Mar 22, 2010 2:32:17 PM	
Type	Message	
Sequence Number	3	
Asynchronous	false	

performDiscussion() : Message		
From	Name	Value
	End Model Element	 :Learner
	Author	wek080083
	Create Date Time	Mar 22, 2010 2:31:36 PM
	Last Modified	Mar 22, 2010 2:32:17 PM
Author	wek080083	
Create Date Time	Mar 22, 2010 2:31:36 PM	

Last Modified	Mar 22, 2010 2:32:17 PM
Type	Message
Sequence Number	4
Asynchronous	false

reviewLearningActivities() : Message		
From	Name	Value
	End Model Element	 :Lecturer
	Author	wek080083
	Create Date Time	Mar 22, 2010 2:31:36 PM
	Last Modified	Mar 22, 2010 2:32:17 PM
Author	wek080083	
Create Date Time	Mar 22, 2010 2:31:36 PM	
Last Modified	Mar 22, 2010 2:32:17 PM	
Type	Message	
Sequence Number	10	
Asynchronous	false	



:LearnerActivity

Name	Value
Author	wek080083
Create Date Time	Mar 22, 2010 2:31:36 PM
Last Modified	Mar 22, 2010 2:32:17 PM
Multiplicity	Unspecified
Active	false
Stopped	false
Multi Object	false

Relationships

getSubmitQuestion() : Message		
To	Name	Value
	End Model Element	 :Lecturer
	Author	wek080083

	Create Date Time	Mar 22, 2010 2:31:36 PM
	Last Modified	Mar 22, 2010 2:38:19 PM
Author	wek080083	
Create Date Time	Mar 22, 2010 2:31:36 PM	
Last Modified	Mar 22, 2010 2:38:19 PM	
Type	Message	
Sequence Number	7	
Action Type	Name	Value
	Name	Return
	Iteration	false
	Asynchronous	false
	Author	wek080083
	Create Date Time	Mar 22, 2010 2:31:36 PM
	Last Modified	Mar 22, 2010 2:38:19 PM
Asynchronous	false	

setSubmitQuestion() : Message		
From	Name	Value
	End Model Element	 :Learner
	Author	wek080083
	Create Date Time	Mar 22, 2010 2:31:36 PM
	Last Modified	Mar 22, 2010 2:38:19 PM
Author	wek080083	
Create Date Time	Mar 22, 2010 2:31:36 PM	
Last Modified	Mar 22, 2010 2:38:19 PM	
Type	Message	
Sequence Number	6	
Asynchronous	false	





:LecturerActivity

Name	Value
Author	wek080083
Create Date Time	Mar 22, 2010 2:31:36 PM
Last Modified	Mar 22, 2010 2:32:17 PM

Multiplicity	Unspecified
Active	false
Stopped	false
Multi Object	false

Relationships

getReceiveAnswer() : Message		
To	Name	Value
	End Model Element	 :Learner
	Author	wek080083
	Create Date Time	Mar 22, 2010 2:31:36 PM
	Last Modified	Mar 22, 2010 2:38:19 PM
Author	wek080083	
Create Date Time	Mar 22, 2010 2:31:36 PM	
Last Modified	Mar 22, 2010 2:38:19 PM	
Type	Message	
Sequence Number	9	
Action Type	Name	Value
	Name	Return
	Iteration	false
	Asynchronous	false
	Author	wek080083
	Create Date Time	Mar 22, 2010 2:31:36 PM
	Last Modified	Mar 22, 2010 2:38:19 PM
Asynchronous	false	

setReceiveAnswer() : Message		
From	Name	Value
	End Model Element	 :Lecturer
	Author	wek080083
	Create Date Time	Mar 22, 2010 2:31:36 PM
	Last Modified	Mar 22, 2010 2:38:19 PM
Author	wek080083	
Create Date Time	Mar 22, 2010 2:31:36 PM	
Last Modified	Mar 22, 2010 2:38:19 PM	

Type	Message
Sequence Number	8
Asynchronous	false

Sequence Diagram

DLS Sequence Diagram 2

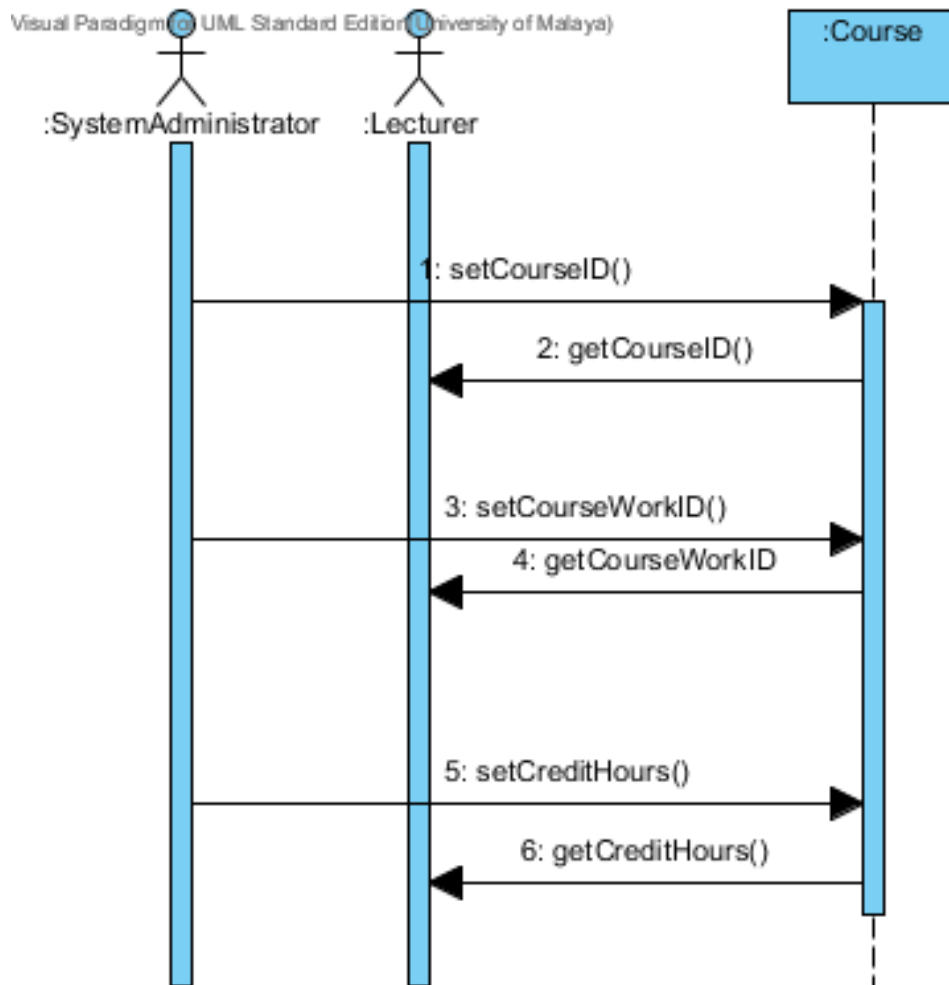

Name	Value
Author	wek080083
Create Date Time	Mar 22, 2010 2:31:36 PM
Last Modified	Mar 22, 2010 2:31:43 PM
Name	DLS Sequence Diagram 2

Summary

Name	Documentation
:SystemAdministrator	Set the course ID of a certain course, set the coursework ID of a course and also set the credit hours of the course
:Course	A framework of all activities related to courses
:Lecturer	Get the course ID, coursework ID and also credit hours of a course.

Details



:SystemAdministrator

Name	Value
Visibility	public
Abstract	false
Leaf	false
Root	false
Author	wek080083
Create Date Time	Mar 22, 2010 2:31:36 PM
Last Modified	Mar 22, 2010 2:32:17 PM
Active	false
Business Model	false

Relationships

setCourseID() : Message		
To	Name	Value
	End Model Element	:Course
	Author	wek080083
	Create Date Time	Mar 22, 2010 2:31:36 PM
	Last Modified	Mar 22, 2010 2:32:17 PM
	Author	wek080083
Create Date Time	Mar 22, 2010 2:31:36 PM	
Last Modified	Mar 22, 2010 2:32:17 PM	
Type	Message	
Sequence Number	1	
Asynchronous	false	

setCourseWorkID() : Message		
To	Name	Value
	End Model Element	:Course
	Author	wek080083

	Create Date Time	Mar 22, 2010 2:31:36 PM
	Last Modified	Mar 22, 2010 2:32:17 PM
Author	wek080083	
Create Date Time	Mar 22, 2010 2:31:36 PM	
Last Modified	Mar 22, 2010 2:32:17 PM	
Type	Message	
Sequence Number	3	
Asynchronous	false	

setCreditHours() : Message		
To	Name	Value
	End Model Element	 :Course
	Author	wek080083
	Create Date Time	Mar 22, 2010 2:31:36 PM
	Last Modified	Mar 22, 2010 2:32:17 PM
Author	wek080083	
Create Date Time	Mar 22, 2010 2:31:36 PM	
Last Modified	Mar 22, 2010 2:32:17 PM	
Type	Message	
Sequence Number	5	
Asynchronous	false	





:Course

Name	Value
Author	wek080083
Create Date Time	Mar 22, 2010 2:31:36 PM
Last Modified	Mar 22, 2010 2:32:17 PM
Multiplicity	Unspecified
Active	false
Stopped	false
Multi Object	false

Relationships

getCourseID() : Message

To	Name	Value
	End Model Element	 :Lecturer
	Author	wek080083
	Create Date Time	Mar 22, 2010 2:31:36 PM
	Last Modified	Mar 22, 2010 2:32:17 PM
Author	wek080083	
Create Date Time	Mar 22, 2010 2:31:36 PM	
Last Modified	Mar 22, 2010 2:32:17 PM	
Type	Message	
Sequence Number	2	
Asynchronous	false	

getCourseWorkID : Message		
To	Name	Value
	End Model Element	 :Lecturer
	Author	wek080083
	Create Date Time	Mar 22, 2010 2:31:36 PM
	Last Modified	Mar 22, 2010 2:32:17 PM
Author	wek080083	
Create Date Time	Mar 22, 2010 2:31:36 PM	
Last Modified	Mar 22, 2010 2:32:17 PM	
Type	Message	
Sequence Number	4	
Asynchronous	false	

getCreditHours() : Message		
To	Name	Value
	End Model Element	 :Lecturer
	Author	wek080083
	Create Date Time	Mar 22, 2010 2:31:36 PM
	Last Modified	Mar 22, 2010 2:32:17 PM
Author	wek080083	
Create Date Time	Mar 22, 2010 2:31:36 PM	
Last Modified	Mar 22, 2010 2:32:17 PM	
Type	Message	

Sequence Number	6
Asynchronous	false

setCourseID() : Message		
From	Name	Value
	End Model Element	 :SystemAdministrator
	Author	wek080083
	Create Date Time	Mar 22, 2010 2:31:36 PM
	Last Modified	Mar 22, 2010 2:32:17 PM
Author	wek080083	
Create Date Time	Mar 22, 2010 2:31:36 PM	
Last Modified	Mar 22, 2010 2:32:17 PM	
Type	Message	
Sequence Number	1	
Asynchronous	false	

setCourseWorkID() : Message		
From	Name	Value
	End Model Element	 :SystemAdministrator
	Author	wek080083
	Create Date Time	Mar 22, 2010 2:31:36 PM
	Last Modified	Mar 22, 2010 2:32:17 PM
Author	wek080083	
Create Date Time	Mar 22, 2010 2:31:36 PM	
Last Modified	Mar 22, 2010 2:32:17 PM	
Type	Message	
Sequence Number	3	
Asynchronous	false	

setCreditHours() : Message		
From	Name	Value
	End Model Element	 :SystemAdministrator
	Author	wek080083
	Create Date Time	Mar 22, 2010 2:31:36 PM
	Last Modified	Mar 22, 2010 2:32:17 PM

Author	wek080083
Create Date Time	Mar 22, 2010 2:31:36 PM
Last Modified	Mar 22, 2010 2:32:17 PM
Type	Message
Sequence Number	5
Asynchronous	false



:Lecturer

Name	Value
Visibility	public
Abstract	false
Leaf	false
Root	false
Author	wek080083
Create Date Time	Mar 22, 2010 2:31:36 PM
Last Modified	Mar 22, 2010 2:32:17 PM
Active	false
Business Model	false

Relationships

getCourseID() : Message		
From	Name	Value
	End Model Element	 :Course
	Author	wek080083
	Create Date Time	Mar 22, 2010 2:31:36 PM
	Last Modified	Mar 22, 2010 2:32:17 PM
	Author	wek080083
Create Date Time	Mar 22, 2010 2:31:36 PM	
Last Modified	Mar 22, 2010 2:32:17 PM	
Type	Message	
Sequence Number	2	
Asynchronous	false	

getCourseWorkID : Message

From	Name	Value
	End Model Element	 :Course
	Author	wek080083
	Create Date Time	Mar 22, 2010 2:31:36 PM
	Last Modified	Mar 22, 2010 2:32:17 PM
Author	wek080083	
Create Date Time	Mar 22, 2010 2:31:36 PM	
Last Modified	Mar 22, 2010 2:32:17 PM	
Type	Message	
Sequence Number	4	
Asynchronous	false	

getCreditHours() : Message		
From	Name	Value
	End Model Element	 :Course
	Author	wek080083
	Create Date Time	Mar 22, 2010 2:31:36 PM
	Last Modified	Mar 22, 2010 2:32:17 PM
Author	wek080083	
Create Date Time	Mar 22, 2010 2:31:36 PM	
Last Modified	Mar 22, 2010 2:32:17 PM	
Type	Message	
Sequence Number	6	
Asynchronous	false	

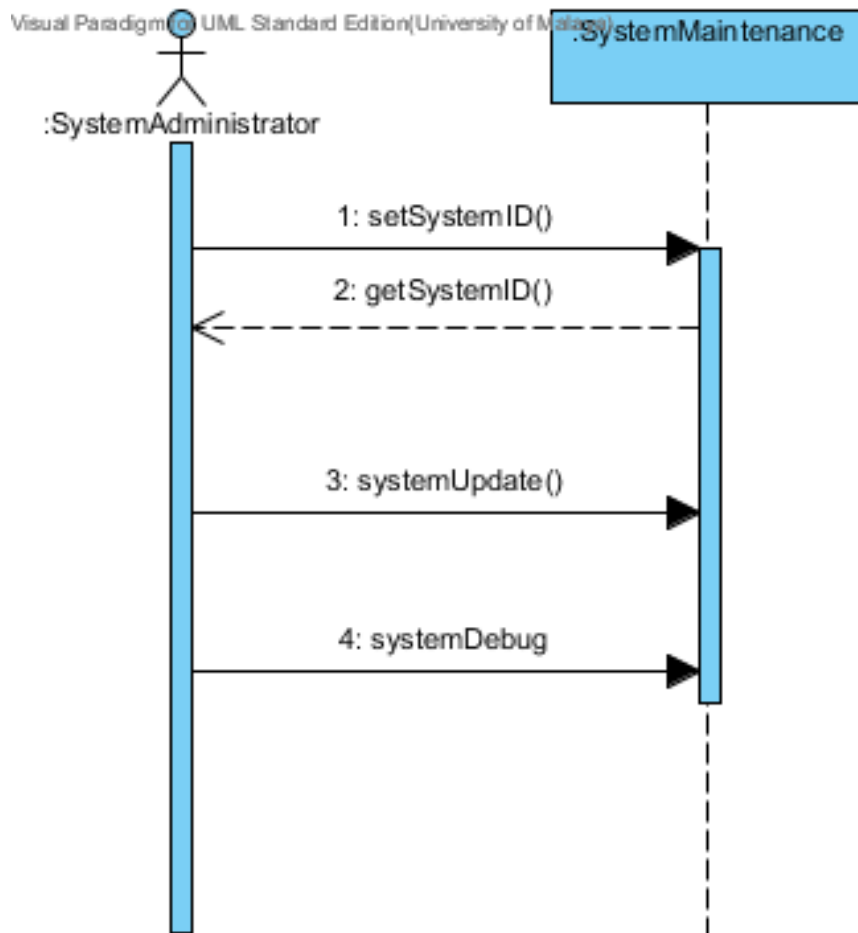

Sequence Diagram

DLS Sequence Diagram 3



Name	Value
Author	wek080083
Create Date Time	Mar 22, 2010 2:31:36 PM
Last Modified	Mar 22, 2010 2:31:45 PM
Name	DLS Sequence Diagram 3

Summary

Name	Documentation
 :SystemAdministrator	Setting this system's ID, get the system's ID and update the system if there are any needs and perform debug if there are any errors in the system. Perform system maintenance.
 :SystemMaintenance	A framework for the system administrator to perform system maintenance.

Details



:SystemAdministrator

Name	Value
Visibility	public
Abstract	false
Leaf	false
Root	false
Author	wek080083
Create Date Time	Mar 22, 2010 2:31:36 PM
Last Modified	Mar 22, 2010 2:32:17 PM
Active	false
Business Model	false

Relationships

setSystemID() : Message		
To	Name	Value
	End Model Element	:SystemMaintenance
	Author	wek080083
	Create Date Time	Mar 22, 2010 2:31:36 PM
	Last Modified	Mar 22, 2010 2:32:17 PM
	Author	wek080083
Create Date Time	Mar 22, 2010 2:31:36 PM	
Last Modified	Mar 22, 2010 2:32:17 PM	
Type	Message	
Sequence Number	1	
Asynchronous	false	

systemUpdate() : Message		
To	Name	Value
	End Model Element	:SystemMaintenance
	Author	wek080083
	Create Date Time	Mar 22, 2010 2:31:36 PM
	Last Modified	Mar 22, 2010 2:32:17 PM
	Author	wek080083
Create Date Time	Mar 22, 2010 2:31:36 PM	
Last Modified	Mar 22, 2010 2:32:17 PM	

Author	wek080083
Create Date Time	Mar 22, 2010 2:31:36 PM
Last Modified	Mar 22, 2010 2:32:17 PM
Type	Message
Sequence Number	3
Asynchronous	false

systemDebug : Message		
To	Name	Value
	End Model Element	 :SystemMaintenance
	Author	wek080083
	Create Date Time	Mar 22, 2010 2:31:36 PM
	Last Modified	Mar 22, 2010 2:32:17 PM
Author	wek080083	
Create Date Time	Mar 22, 2010 2:31:36 PM	
Last Modified	Mar 22, 2010 2:32:17 PM	
Type	Message	
Sequence Number	4	
Asynchronous	false	

getSystemID() : Message		
From	Name	Value
	End Model Element	 :SystemMaintenance
	Author	wek080083
	Create Date Time	Mar 22, 2010 2:31:36 PM
	Last Modified	Mar 22, 2010 2:32:17 PM
Author	wek080083	
Create Date Time	Mar 22, 2010 2:31:36 PM	
Last Modified	Mar 22, 2010 2:32:17 PM	
Type	Message	
Sequence Number	2	
Action Type	Name	Value
	Name	Return
	Iteration	false
	Asynchronous	false

	Author	wek080083
	Create Date Time	Mar 22, 2010 2:31:36 PM
	Last Modified	Mar 22, 2010 2:32:17 PM
Asynchronous	false	



:SystemMaintenance

Name	Value
Author	wek080083
Create Date Time	Mar 22, 2010 2:31:36 PM
Last Modified	Mar 22, 2010 2:32:17 PM
Multiplicity	Unspecified
Active	false
Stopped	false
Multi Object	false

Relationships

getSystemID() : Message		
To	Name	Value
	End Model Element	 :SystemAdministrator
	Author	wek080083
	Create Date Time	Mar 22, 2010 2:31:36 PM
	Last Modified	Mar 22, 2010 2:32:17 PM
Author	wek080083	
Create Date Time	Mar 22, 2010 2:31:36 PM	
Last Modified	Mar 22, 2010 2:32:17 PM	
Type	Message	
Sequence Number	2	
Action Type	Name	Value
	Name	Return
	Iteration	false
	Asynchronous	false
	Author	wek080083
	Create Date Time	Mar 22, 2010 2:31:36 PM

	Last Modified	Mar 22, 2010 2:32:17 PM
Asynchronous	false	

setSystemID() : Message		
From	Name	Value
	End Model Element	 :SystemAdministrator
	Author	wek080083
	Create Date Time	Mar 22, 2010 2:31:36 PM
	Last Modified	Mar 22, 2010 2:32:17 PM
Author	wek080083	
Create Date Time	Mar 22, 2010 2:31:36 PM	
Last Modified	Mar 22, 2010 2:32:17 PM	
Type	Message	
Sequence Number	1	
Asynchronous	false	

systemUpdate() : Message		
From	Name	Value
	End Model Element	 :SystemAdministrator
	Author	wek080083
	Create Date Time	Mar 22, 2010 2:31:36 PM
	Last Modified	Mar 22, 2010 2:32:17 PM
Author	wek080083	
Create Date Time	Mar 22, 2010 2:31:36 PM	
Last Modified	Mar 22, 2010 2:32:17 PM	
Type	Message	
Sequence Number	3	
Asynchronous	false	

systemDebug : Message		
From	Name	Value
	End Model Element	 :SystemAdministrator
	Author	wek080083
	Create Date Time	Mar 22, 2010 2:31:36 PM
	Last Modified	Mar 22, 2010 2:32:17 PM

Author	wek080083
Create Date Time	Mar 22, 2010 2:31:36 PM
Last Modified	Mar 22, 2010 2:32:17 PM
Type	Message
Sequence Number	4
Asynchronous	false